

# Podium Steps

BS 8620:2016

Width (W)	Length (L)	Working Height (wh)	Tower Height (H)	Platform Height (ph)
0.65m	1.37m	3.25m	2.26m	1.25m

## Tower Components

Item	Description	Quantity
1	Podium Mainframe	1
2	Self Closing Gates	1
3	Platform	1
4	Stabilisers	2
5	Ladder	1
6	Instruction Manual	1

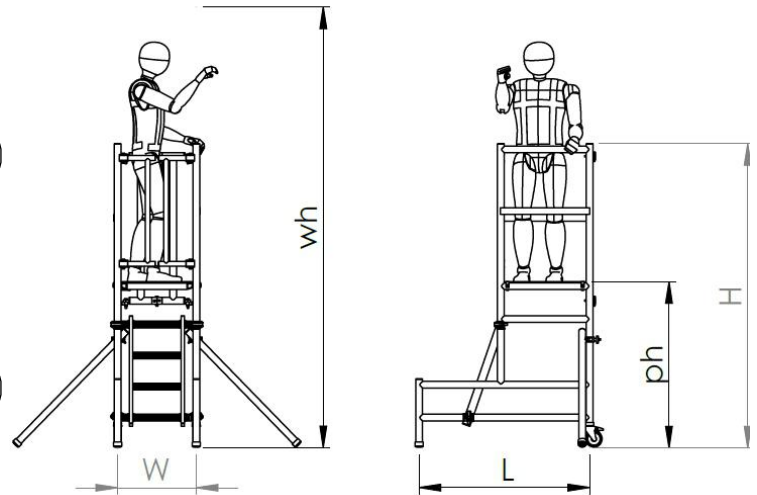
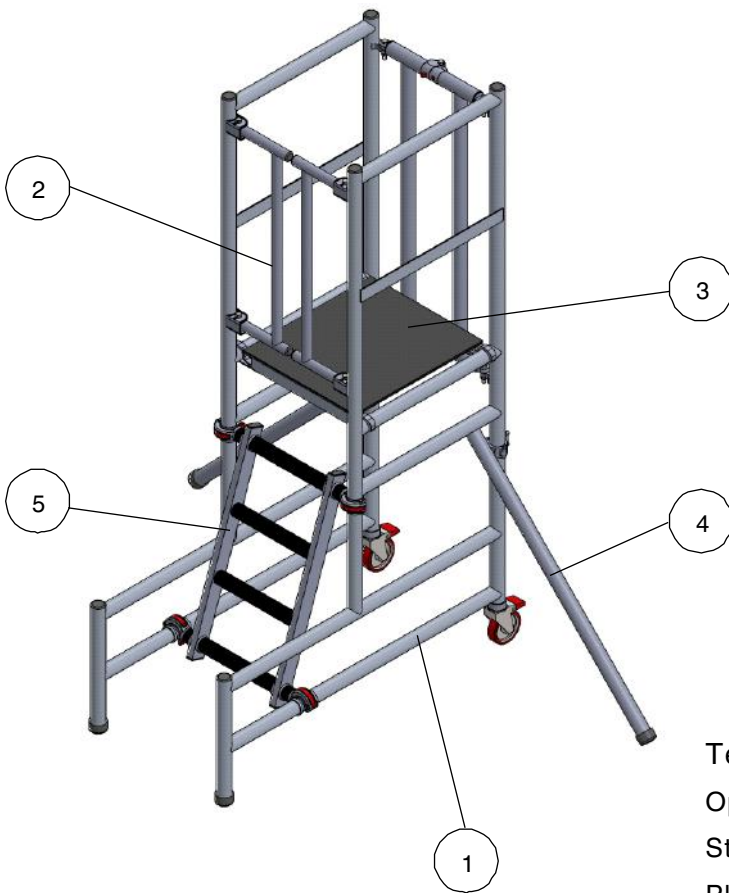

## Technical information:

Open Dimensions:	(H)2.26 X (L)1.37m X (W)0.65m
Storage Dimensions:	(H)2.26 X (L)1.37m X (W)0.26m
Platform Dimensions:	0.6m X 0.53m
Platform Height (ph):	1.0m      1.25m
Working Height (wh):	3.0m      3.25m
Maximum Working Load:	150kg
Weight:	35kg



# Aluminium Scaffold Towers Ltd.

01353 778811

sales@aluminium-scaffoldtowers.co.uk

www.aluminium-scaffoldtowers.co.uk